

# DTC114EET1 Series

## Bias Resistor Transistor

### NPN Silicon Surface Mount Transistor with Monolithic Bias Resistor Network

This new series of digital transistors is designed to replace a single device and its external resistor bias network. The BRT (Bias Resistor Transistor) contains a single transistor with a monolithic bias network consisting of two resistors; a series base resistor and a base-emitter resistor. The BRT eliminates these individual components by integrating them into a single device. The use of a BRT can reduce both system cost and board space. The device is housed in the SC-75/SOT-416 package which is designed for low power surface mount applications.

- Simplifies Circuit Design
- Reduces Board Space
- Reduces Component Count
- The SC-75/SOT-416 package can be soldered using wave or reflow. The modified gull-winged leads absorb thermal stress during soldering eliminating the possibility of damage to the die.
- Available in 8 mm, 7 inch/3000 Unit Tape & Reel

#### MAXIMUM RATINGS ( $T_A = 25^\circ\text{C}$ unless otherwise noted)

Rating	Symbol	Value	Unit
Collector-Base Voltage	$V_{CB0}$	50	Vdc
Collector-Emitter Voltage	$V_{CEO}$	50	Vdc
Collector Current	$I_C$	100	mAdc



**ON Semiconductor®**

<http://onsemi.com>

### NPN SILICON BIAS RESISTOR TRANSISTORS

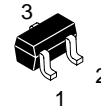
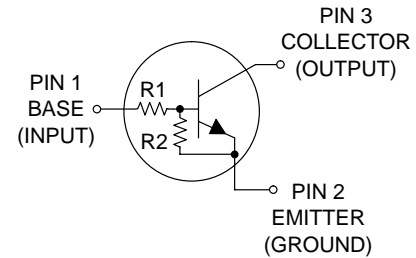

**SC-75/SOT-416  
CASE 463  
STYLE 1**

#### MARKING DIAGRAM

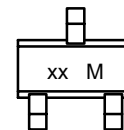

xx = Specific Device Code  
(See Marking Table on page 2)  
M = Date Code

## DTC114EET1 Series

### DEVICE MARKING AND RESISTOR VALUES

Device	Marking	R1 (K)	R2 (K)	Shipping
DTC114EET1	8A	10	10	3000/Tape & Reel
DTC124EET1	8B	22	22	
DTC144EET1	8C	47	47	
DTC114YET1	8D	10	47	
DTC114TET1	94	10	$\infty$	
DTC143TET1	8F	4.7	$\infty$	
DTC123EET1	8H	2.2	2.2	
DTC143EET1	8J	4.7	4.7	
DTC143ZET1	8K	4.7	47	
DTC124XET1	8L	22	47	
DTC123JET1	8M	2.2	47	
DTC115EET1	8N	100	100	
DTC144WET1	8P	47	22	

### THERMAL CHARACTERISTICS

Characteristic	Symbol	Max	Unit
Total Device Dissipation, FR-4 Board (Note 1) @ $T_A = 25^\circ\text{C}$ Derate above $25^\circ\text{C}$	$P_D$	200 1.6	mW mW/ $^\circ\text{C}$
Thermal Resistance, Junction-to-Ambient (Note 1)	$R_{\theta JA}$	600	$^\circ\text{C}/\text{W}$
Total Device Dissipation, FR-4 Board (Note 2) @ $T_A = 25^\circ\text{C}$ Derate above $25^\circ\text{C}$	$P_D$	300 2.4	mW mW/ $^\circ\text{C}$
Thermal Resistance, Junction-to-Ambient (Note 2)	$R_{\theta JA}$	400	$^\circ\text{C}/\text{W}$
Junction and Storage Temperature Range	$T_J, T_{stg}$	-55 to +150	$^\circ\text{C}$

1. FR-4 @ Minimum Pad
2. FR-4 @  $1.0 \times 1.0$  Inch Pad

# DTC114EET1 Series

## ELECTRICAL CHARACTERISTICS ( $T_A = 25^\circ\text{C}$ unless otherwise noted)

Characteristic	Symbol	Min	Typ	Max	Unit
<b>OFF CHARACTERISTICS</b>					
Collector-Base Cutoff Current ( $V_{CB} = 50\text{ V}, I_E = 0$ )	$I_{CBO}$	-	-	100	nAdc
Collector-Emitter Cutoff Current ( $V_{CE} = 50\text{ V}, I_B = 0$ )	$I_{CEO}$	-	-	500	nAdc
Emitter-Base Cutoff Current ( $V_{EB} = 6.0\text{ V}, I_C = 0$ )	$I_{EBO}$	-	-	0.5	mAdc
DTC114EET1		-	-	0.2	
DTC124EET1		-	-	0.1	
DTC144EET1		-	-	0.2	
DTC114YET1		-	-	0.9	
DTC114TET1		-	-	1.9	
DTC143TET1		-	-	2.3	
DTC123EET1		-	-	1.5	
DTC143EET1		-	-	0.18	
DTC143ZET1		-	-	0.13	
DTC124XET1		-	-	0.2	
DTC123JET1		-	-	0.05	
DTC115EET1		-	-	0.13	
DTC144WET1		-	-		
Collector-Base Breakdown Voltage ( $I_C = 10\ \mu\text{A}, I_E = 0$ )	$V_{(BR)CBO}$	50	-	-	Vdc
Collector-Emitter Breakdown Voltage (Note 3) ( $I_C = 2.0\text{ mA}, I_B = 0$ )	$V_{(BR)CEO}$	50	-	-	Vdc

## ON CHARACTERISTICS (Note 3)

DC Current Gain ( $V_{CE} = 10\text{ V}, I_C = 5.0\text{ mA}$ )	$h_{FE}$	35	60	-	
DTC114EET1		60	100	-	
DTC124EET1		80	140	-	
DTC144EET1		80	140	-	
DTC114YET1		80	140	-	
DTC114TET1		160	350	-	
DTC143TET1		160	350	-	
DTC123EET1		8.0	15	-	
DTC143EET1		15	30	-	
DTC143ZET1		80	200	-	
DTC124XET1		80	150	-	
DTC123JET1		80	140	-	
DTC115EET1		80	150	-	
DTC144WET1		80	140	-	
Collector-Emitter Saturation Voltage ( $I_C = 10\text{ mA}, I_B = 0.3\text{ mA}$ ) ( $I_C = 10\text{ mA}, I_B = 5\text{ mA}$ ) DTC123EET1 ( $I_C = 10\text{ mA}, I_B = 1\text{ mA}$ ) DTC143TET1/DTC114TET1/ DTC143EET1/DTC143ZET1/DTC124XET1	$V_{CE(sat)}$	-	-	0.25	Vdc
Output Voltage (on) ( $V_{CC} = 5.0\text{ V}, V_B = 2.5\text{ V}, R_L = 1.0\text{ k}\Omega$ )	$V_{OL}$	-	-	0.2	Vdc
DTC114EET1		-	-	0.2	
DTC124EET1		-	-	0.2	
DTC114YET1		-	-	0.2	
DTC114TET1		-	-	0.2	
DTC143TET1		-	-	0.2	
DTC123EET1		-	-	0.2	
DTC143EET1		-	-	0.2	
DTC143ZET1		-	-	0.2	
DTC124XET1		-	-	0.2	
DTC123JET1		-	-	0.2	
( $V_{CC} = 5.0\text{ V}, V_B = 3.5\text{ V}, R_L = 1.0\text{ k}\Omega$ ) DTC144EET1		-	-	0.2	
( $V_{CC} = 5.0\text{ V}, V_B = 5.5\text{ V}, R_L = 1.0\text{ k}\Omega$ ) DTC115EET1		-	-	0.2	
( $V_{CC} = 5.0\text{ V}, V_B = 4.0\text{ V}, R_L = 1.0\text{ k}\Omega$ ) DTC144WET1		-	-	0.2	
Output Voltage (off) ( $V_{CC} = 5.0\text{ V}, V_B = 0.5\text{ V}, R_L = 1.0\text{ k}\Omega$ ) ( $V_{CC} = 5.0\text{ V}, V_B = 0.25\text{ V}, R_L = 1.0\text{ k}\Omega$ )	$V_{OH}$	4.9	-	-	Vdc
DTC143TET1					
DTC143ZET1					
DTC114TET1					

3. Pulse Test: Pulse Width < 300  $\mu\text{s}$ , Duty Cycle < 2.0%

# DTC114EET1 Series

## ELECTRICAL CHARACTERISTICS ( $T_A = 25^\circ\text{C}$ unless otherwise noted) (Continued)

Characteristic	Symbol	Min	Typ	Max	Unit
Input Resistor	DTC114EET1	7.0	10	13	k $\Omega$
	DTC124EET1	15.4	22	28.6	
	DTC144EET1	32.9	47	61.1	
	DTC114YET1	7.0	10	13	
	DTC114TET1	7.0	10	13	
	DTC143TET1	3.3	4.7	6.1	
	DTC123EET1	1.5	2.2	2.9	
	DTC143EET1	3.3	4.7	6.1	
	DTC143ZET1	3.3	4.7	6.1	
	DTC124XET1	15.4	22	28.6	
	DTC123JET1	1.54	2.2	2.86	
	DTC115EET1	70	100	130	
	DTC144WET1	32.9	47	61.1	
	Resistor Ratio	DTC114EET1/DTC124EET1/DTC144EET1/ DTC115EET1	0.8	1.0	
DTC114YET1		0.17	0.21	0.25	
DTC143TET1/DTC114TET1		-	-	-	
DTC123EET1/DTC143EET1		0.8	1.0	1.2	
DTC143ZET1		0.055	0.1	0.185	
DTC124XET1		0.38	0.47	0.56	
DTC123JET1		0.038	0.047	0.056	
DTC144WET1		1.7	2.1	2.6	

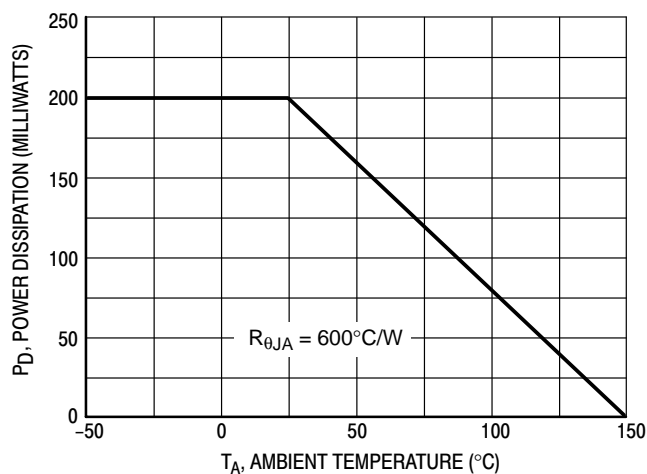

Figure 1. Derating Curve

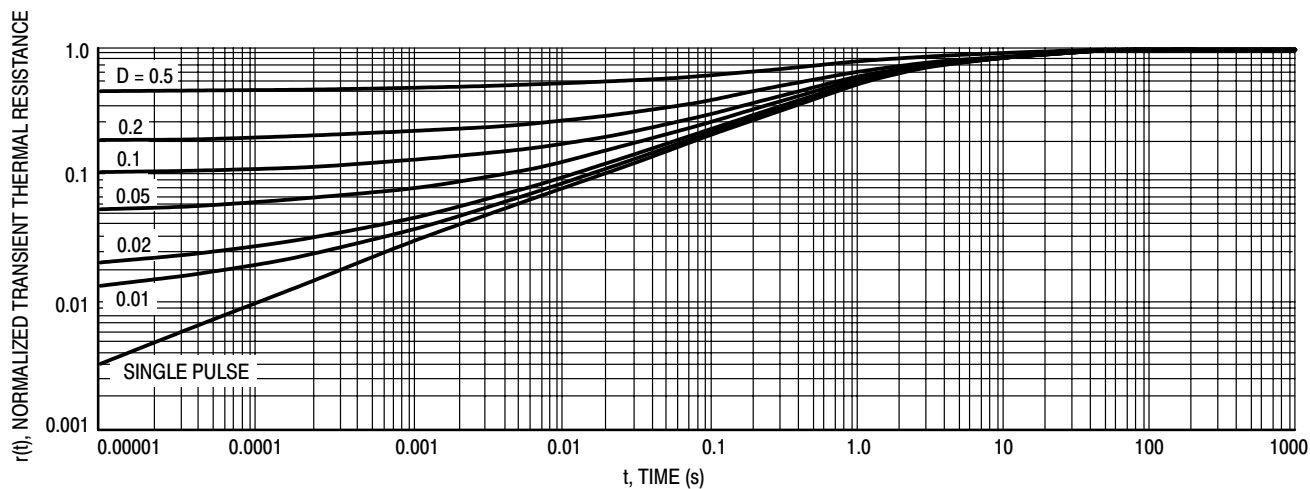

Figure 2. Normalized Thermal Response

# DTC114EET1 Series

## TYPICAL ELECTRICAL CHARACTERISTICS - DTC114EET1

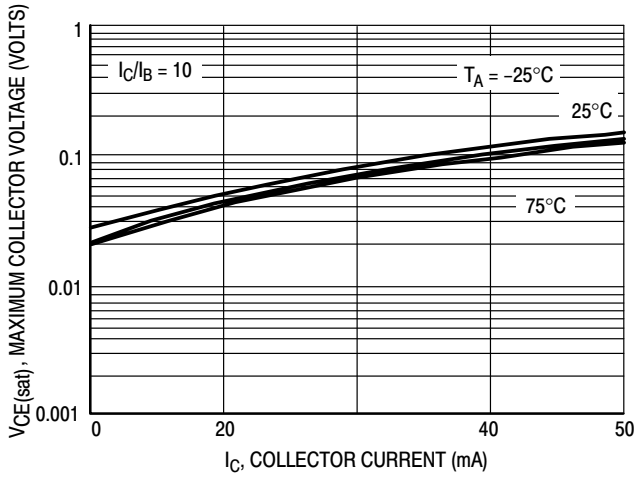

Figure 3.  $V_{CE(sat)}$  versus  $I_C$

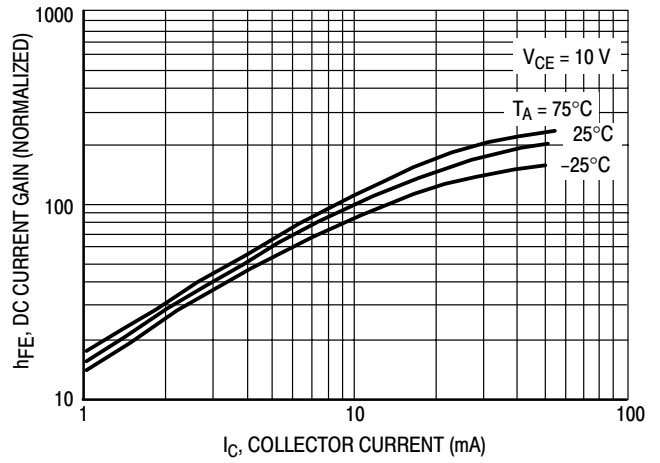

Figure 4. DC Current Gain

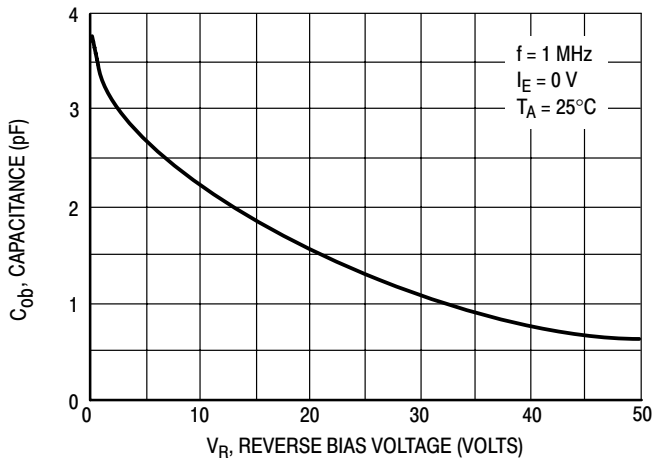

Figure 5. Output Capacitance

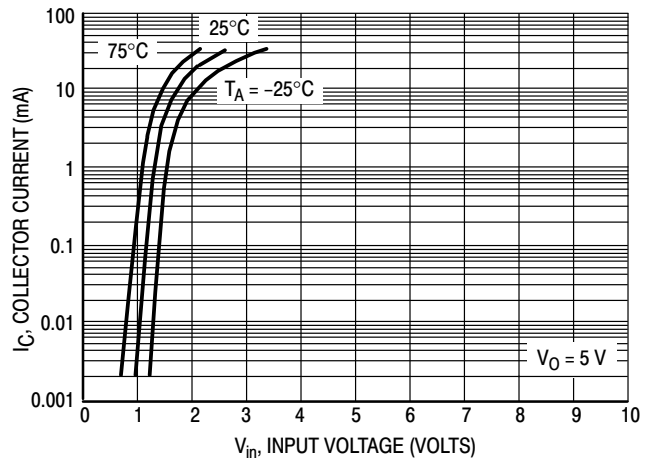

Figure 6. Output Current versus Input Voltage

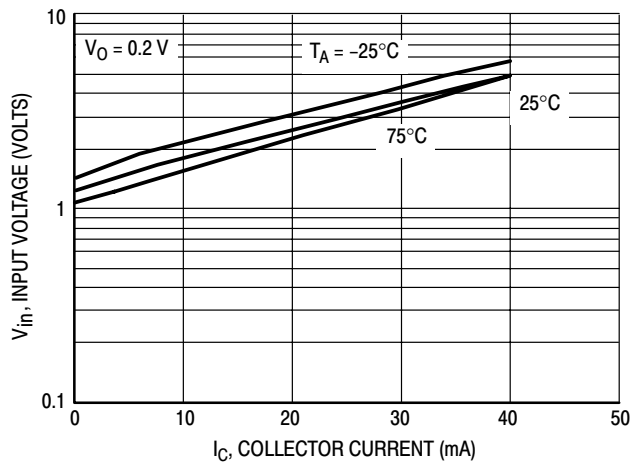

Figure 7. Input Voltage versus Output Current

# DTC114EET1 Series

## TYPICAL ELECTRICAL CHARACTERISTICS - DTC124EET1

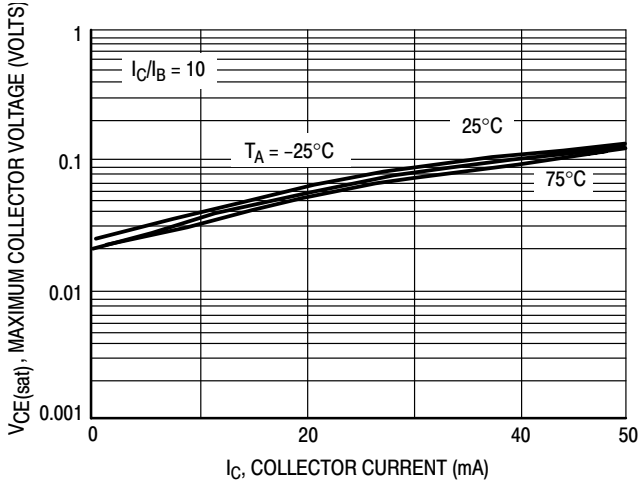

Figure 8.  $V_{CE(sat)}$  versus  $I_C$

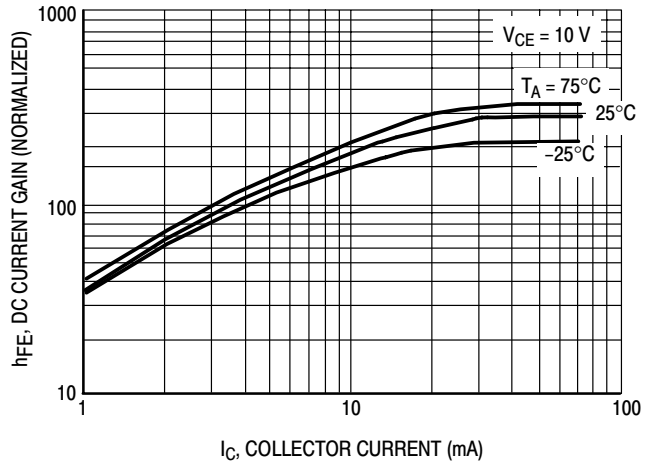

Figure 9. DC Current Gain

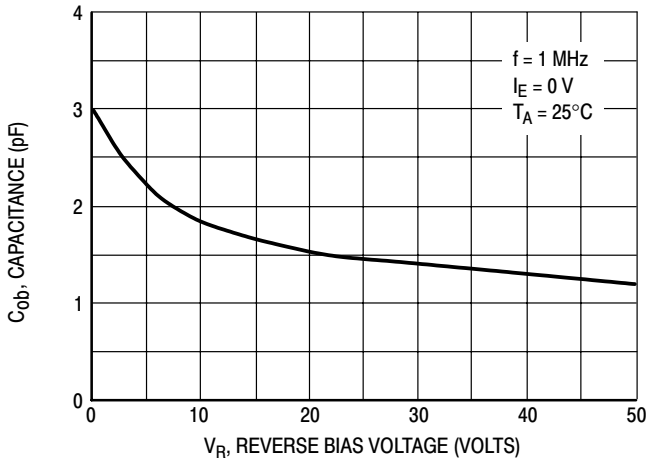

Figure 10. Output Capacitance

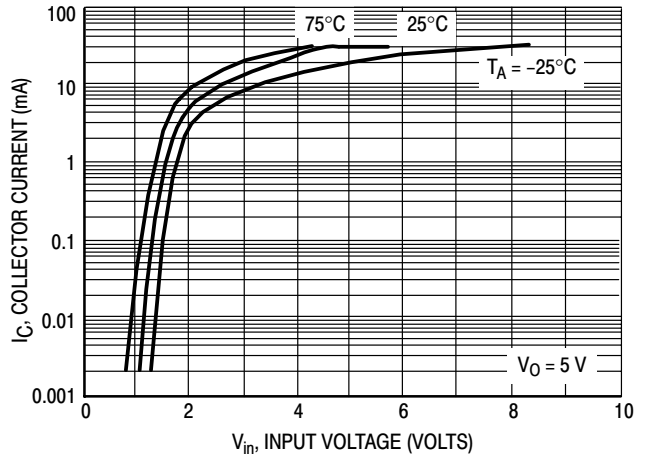

Figure 11. Output Current versus Input Voltage

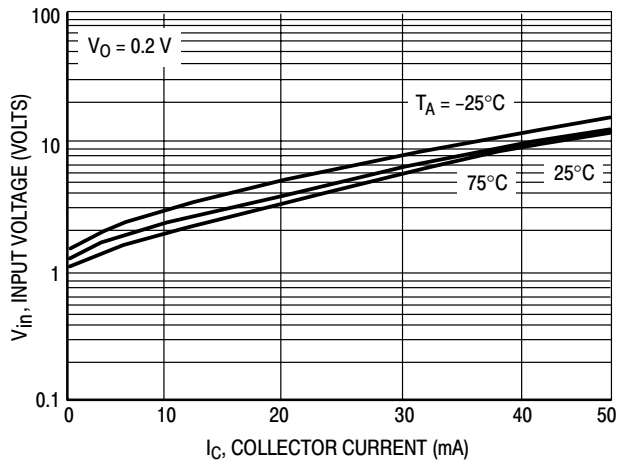

Figure 12. Input Voltage versus Output Current

# DTC114EET1 Series

## TYPICAL ELECTRICAL CHARACTERISTICS - DTC114EET1

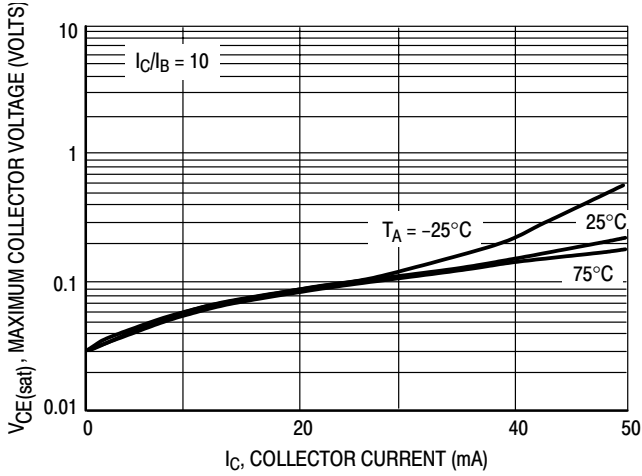

Figure 13.  $V_{CE(sat)}$  versus  $I_C$

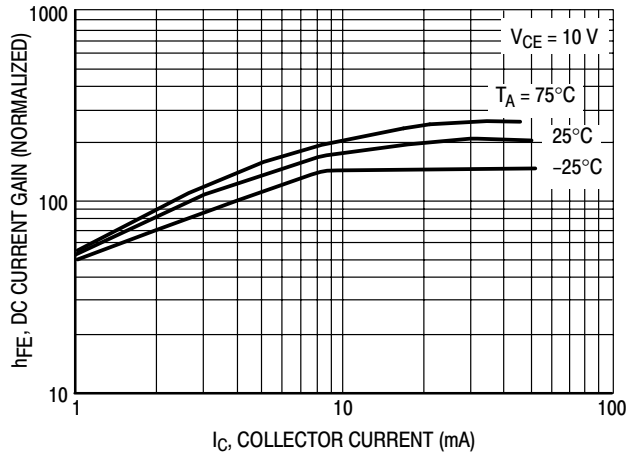

Figure 14. DC Current Gain

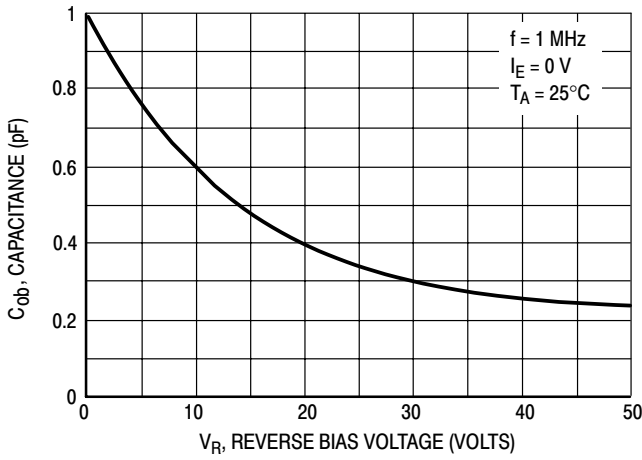

Figure 15. Output Capacitance

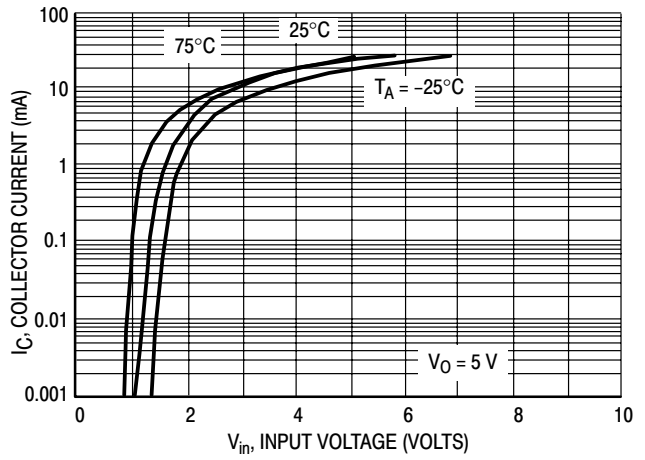

Figure 16. Output Current versus Input Voltage

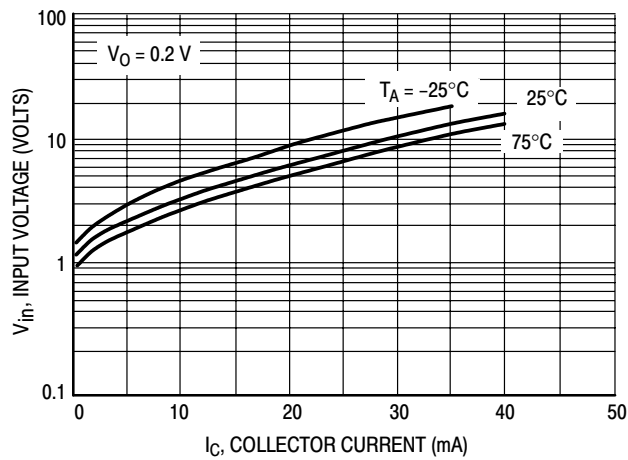

Figure 17. Input Voltage versus Output Current

# DTC114EET1 Series

## TYPICAL ELECTRICAL CHARACTERISTICS - DTC114YET1

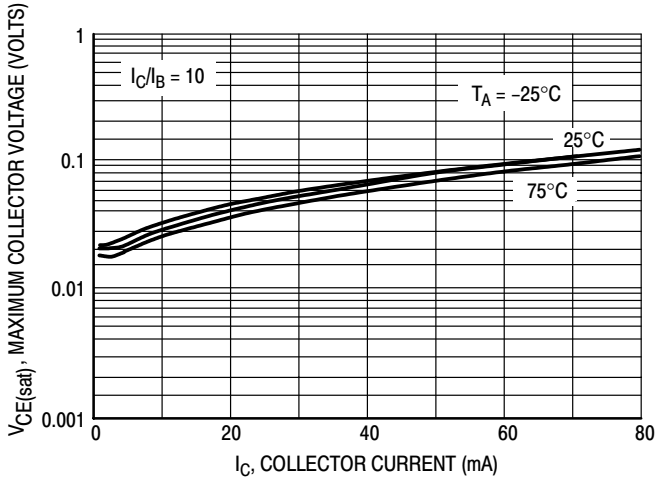

Figure 18.  $V_{CE(sat)}$  versus  $I_C$

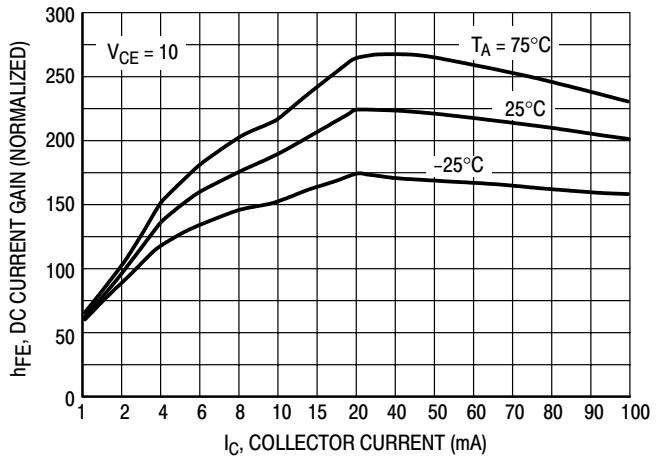

Figure 19. DC Current Gain

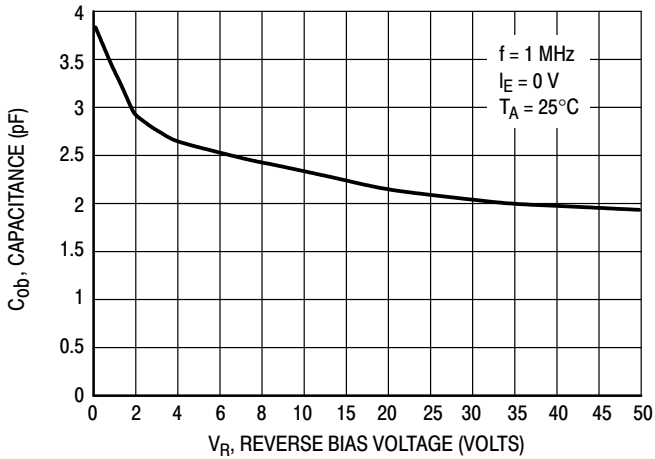

Figure 20. Output Capacitance

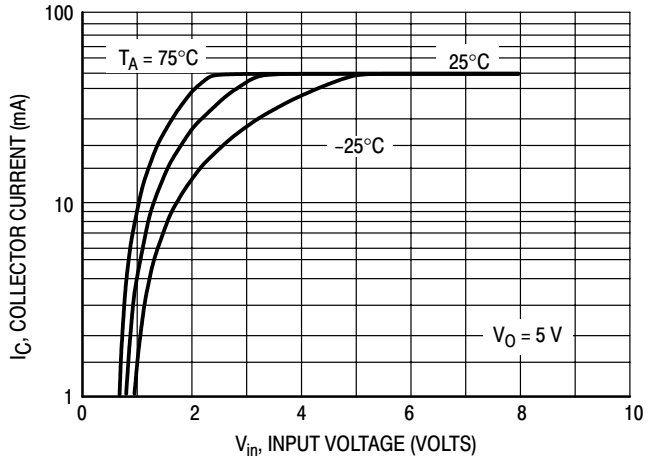

Figure 21. Output Current versus Input Voltage

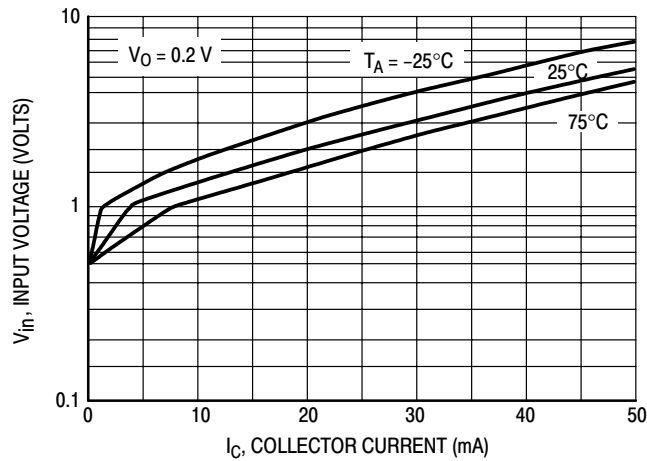

Figure 22. Input Voltage versus Output Current

# DTC114EET1 Series

## TYPICAL APPLICATIONS FOR NPN BRTs

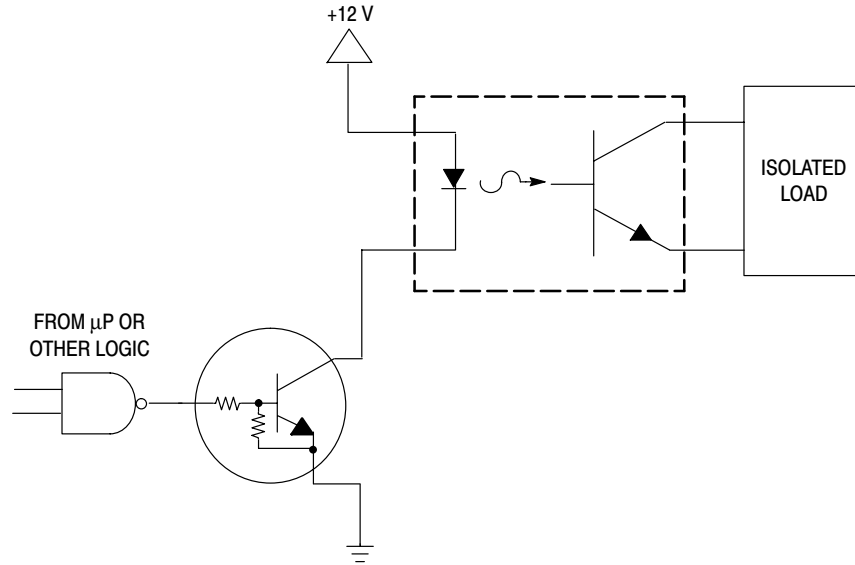

Figure 23. Level Shifter: Connects 12 or 24 Volt Circuits to Logic

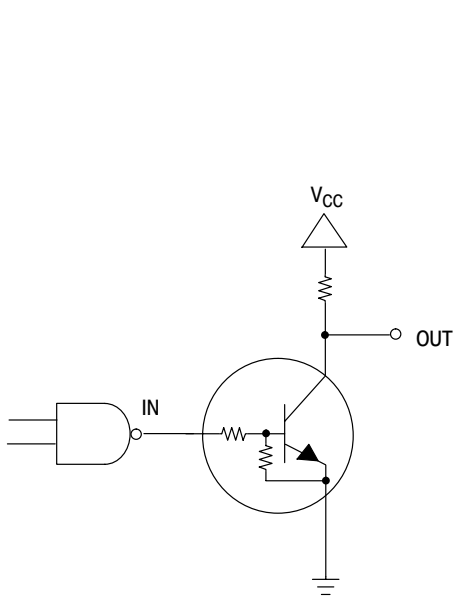

Figure 24. Open Collector Inverter:  
Inverts the Input Signal

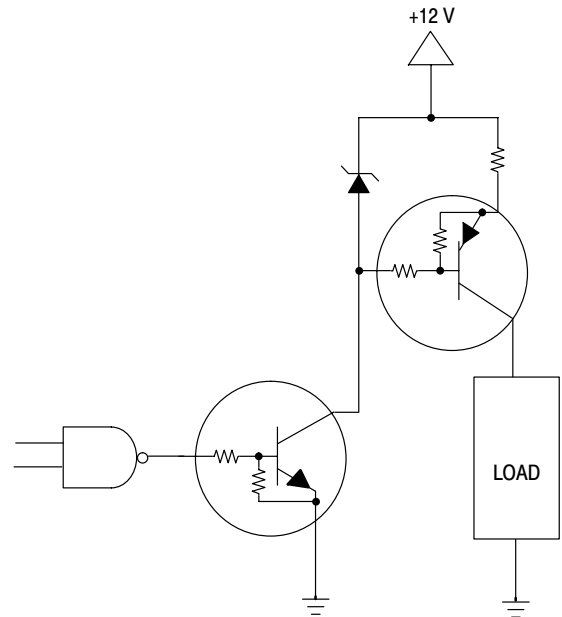

Figure 25. Inexpensive, Unregulated Current Source

**INFORMATION FOR USING THE SOT-416 SURFACE MOUNT PACKAGE**

**MINIMUM RECOMMENDED FOOTPRINT FOR SURFACE MOUNTED APPLICATIONS**

Surface mount board layout is a critical portion of the total design. The footprint for the semiconductor packages must be the correct size to insure proper solder connection

interface between the board and the package. With the correct pad geometry, the packages will self align when subjected to a solder reflow process.

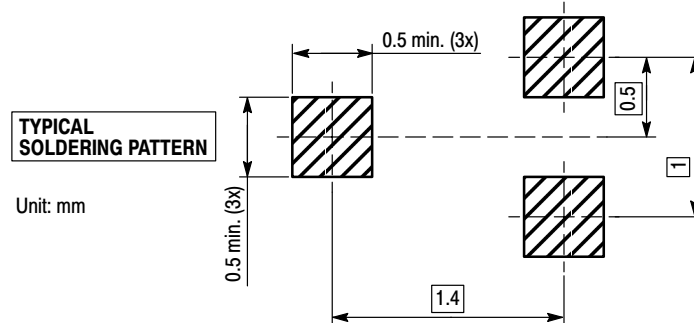

**SOT-416/SC-90 POWER DISSIPATION**

The power dissipation of the SOT-416/SC-90 is a function of the pad size. This can vary from the minimum pad size for soldering to the pad size given for maximum power dissipation. Power dissipation for a surface mount device is determined by  $T_{J(max)}$ , the maximum rated junction temperature of the die,  $R_{\theta JA}$ , the thermal resistance from the device junction to ambient; and the operating temperature,  $T_A$ . Using the values provided on the data sheet,  $P_D$  can be calculated as follows.

$$P_D = \frac{T_{J(max)} - T_A}{R_{\theta JA}}$$

The values for the equation are found in the maximum ratings table on the data sheet. Substituting these values into

the equation for an ambient temperature  $T_A$  of 25°C, one can calculate the power dissipation of the device which in this case is 125 milliwatts.

$$P_D = \frac{150^\circ\text{C} - 25^\circ\text{C}}{833^\circ\text{C/W}} = 150 \text{ milliwatts}$$

The 833°C/W assumes the use of the recommended footprint on a glass epoxy printed circuit board to achieve a power dissipation of 150 milliwatts. Another alternative would be to use a ceramic substrate or an aluminum core board such as Thermal Clad™. Using a board material such as Thermal Clad, a higher power dissipation can be achieved using the same footprint.

**SOLDERING PRECAUTIONS**

The melting temperature of solder is higher than the rated temperature of the device. When the entire device is heated to a high temperature, failure to complete soldering within a short time could result in device failure. Therefore, the following items should always be observed in order to minimize the thermal stress to which the devices are subjected.

- Always preheat the device.
- The delta temperature between the preheat and soldering should be 100°C or less.\*
- When preheating and soldering, the temperature of the leads and the case must not exceed the maximum temperature ratings as shown on the data sheet. When using infrared heating with the reflow soldering method, the difference should be a maximum of 10°C.

- The soldering temperature and time should not exceed 260°C for more than 10 seconds.
- When shifting from preheating to soldering, the maximum temperature gradient should be 5°C or less.
- After soldering has been completed, the device should be allowed to cool naturally for at least three minutes. Gradual cooling should be used as the use of forced cooling will increase the temperature gradient and result in latent failure due to mechanical stress.
- Mechanical stress or shock should not be applied during cooling

\* Soldering a device without preheating can cause excessive thermal shock and stress which can result in damage to the device.

# DTC114EET1 Series

## SOLDER STENCIL GUIDELINES

Prior to placing surface mount components onto a printed circuit board, solder paste must be applied to the pads. A solder stencil is required to screen the optimum amount of solder paste onto the footprint. The stencil is made of brass or stainless steel with a typical thickness of 0.008 inches.

The stencil opening size for the surface mounted package should be the same as the pad size on the printed circuit board, i.e., a 1:1 registration.

### TYPICAL SOLDER HEATING PROFILE

For any given circuit board, there will be a group of control settings that will give the desired heat pattern. The operator must set temperatures for several heating zones, and a figure for belt speed. Taken together, these control settings make up a heating “profile” for that particular circuit board. On machines controlled by a computer, the computer remembers these profiles from one operating session to the next. Figure 7 shows a typical heating profile for use when soldering a surface mount device to a printed circuit board. This profile will vary among soldering systems but it is a good starting point. Factors that can affect the profile include the type of soldering system in use, density and types of components on the board, type of solder used, and the type of board or substrate material being used. This profile shows temperature versus time.

The line on the graph shows the actual temperature that might be experienced on the surface of a test board at or near a central solder joint. The two profiles are based on a high density and a low density board. The Vitronics SMD310 convection/infrared reflow soldering system was used to generate this profile. The type of solder used was 62/36/2 Tin Lead Silver with a melting point between 177-189 °C. When this type of furnace is used for solder reflow work, the circuit boards and solder joints tend to heat first. The components on the board are then heated by conduction. The circuit board, because it has a large surface area, absorbs the thermal energy more efficiently, then distributes this energy to the components. Because of this effect, the main body of a component may be up to 30 degrees cooler than the adjacent solder joints.

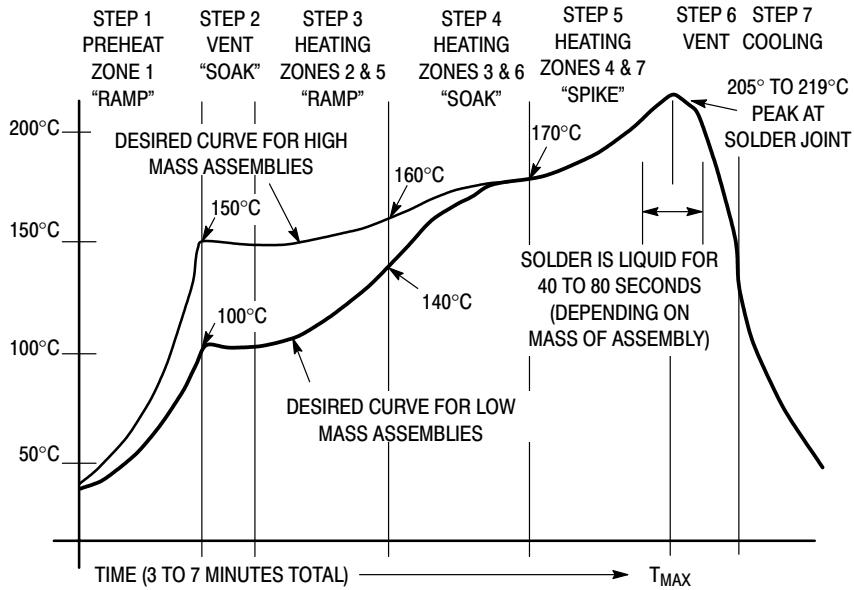
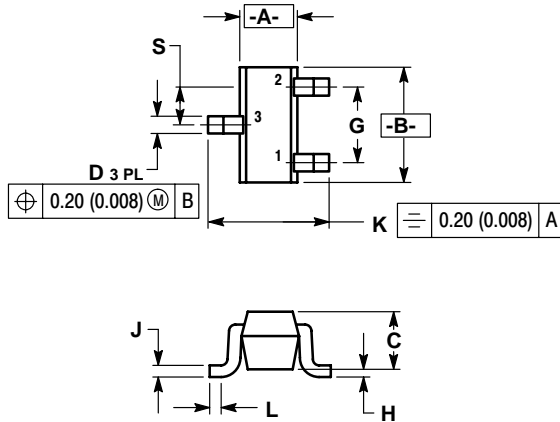

Figure 26. Typical Solder Heating Profile

# DTC114EET1 Series

## PACKAGE DIMENSIONS

SC-75/SOT-416  
CASE 463-01  
ISSUE B



**NOTES:**

1. DIMENSIONING AND TOLERANCING PER ANSI Y14.5M, 1982.
2. CONTROLLING DIMENSION: MILLIMETER.

DIM	MILLIMETERS		INCHES	
	MIN	MAX	MIN	MAX
A	0.70	0.80	0.028	0.031
B	1.40	1.80	0.055	0.071
C	0.60	0.90	0.024	0.035
D	0.15	0.30	0.006	0.012
G	1.00 BSC		0.039 BSC	
H	---	0.10	---	0.004
J	0.10	0.25	0.004	0.010
K	1.45	1.75	0.057	0.069
L	0.10	0.20	0.004	0.008
S	0.50 BSC		0.020 BSC	

**STYLE 1:**

- PIN 1. BASE
- EMITTER
- COLLECTOR

Thermal Clad is a trademark of the Bergquist Company.

**ON Semiconductor** and  are registered trademarks of Semiconductor Components Industries, LLC (SCILLC). SCILLC reserves the right to make changes without further notice to any products herein. SCILLC makes no warranty, representation or guarantee regarding the suitability of its products for any particular purpose, nor does SCILLC assume any liability arising out of the application or use of any product or circuit, and specifically disclaims any and all liability, including without limitation special, consequential or incidental damages. "Typical" parameters which may be provided in SCILLC data sheets and/or specifications can and do vary in different applications and actual performance may vary over time. All operating parameters, including "Typicals" must be validated for each customer application by customer's technical experts. SCILLC does not convey any license under its patent rights nor the rights of others. SCILLC products are not designed, intended, or authorized for use as components in systems intended for surgical implant into the body, or other applications intended to support or sustain life, or for any other application in which the failure of the SCILLC product could create a situation where personal injury or death may occur. Should Buyer purchase or use SCILLC products for any such unintended or unauthorized application, Buyer shall indemnify and hold SCILLC and its officers, employees, subsidiaries, affiliates, and distributors harmless against all claims, costs, damages, and expenses, and reasonable attorney fees arising out of, directly or indirectly, any claim of personal injury or death associated with such unintended or unauthorized use, even if such claim alleges that SCILLC was negligent regarding the design or manufacture of the part. SCILLC is an Equal Opportunity/Affirmative Action Employer.

### PUBLICATION ORDERING INFORMATION

**Literature Fulfillment:**

Literature Distribution Center for ON Semiconductor  
P.O. Box 5163, Denver, Colorado 80217 USA  
**Phone:** 303-675-2175 or 800-344-3860 Toll Free USA/Canada  
**Fax:** 303-675-2176 or 800-344-3867 Toll Free USA/Canada  
**Email:** ONlit@hibbertco.com

**N. American Technical Support:** 800-282-9855 Toll Free USA/Canada

**JAPAN:** ON Semiconductor, Japan Customer Focus Center  
2-9-1 Kamimeguro, Meguro-ku, Tokyo, Japan 153-0051  
**Phone:** 81-3-5773-3850

**ON Semiconductor Website:** <http://onsemi.com>

For additional information, please contact your local Sales Representative.